



# Technical Data

Specification & Capacities

## MPKIOWD

S.N: \_\_\_\_\_



3,0kW/4,1Hp



5' 07" – 13' 09"



1950lb



B30.5

[ft] [lb]







Via Campardone, 1  
31014 Colle Umberto – Italy  
Tel. +39 0438 1710083  
Mail: info@jekko.it  
Web: www.jekko.it

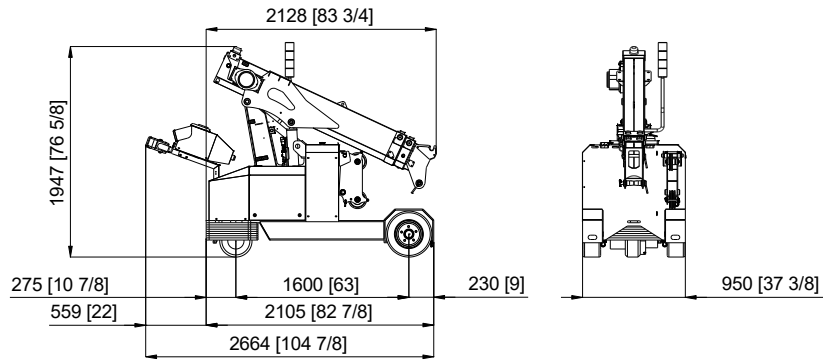

Date	Feb. 20 <sup>th</sup> 2017
REV.	<b>10.1</b>

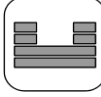

## MPK10WD – OVERALL DIMENSIONS









		lb
		3080
		1100
	<b>Tot.</b>	<b>4180</b>

	n° 1 24V 345 Ah		3,0kW 4,2Hp
---	-----------------	---	-------------

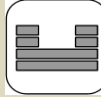
	mph	1,9
	10°	

	-25/50°	13s
	ft 5'6"-13'8"	30s

							
		3080			1100		
	ft	0' 08"	1' 08"	3' 03"	4' 11"	6' 07"	8' 02"
	lb	0	1950	1950	1760	1320	880
	lb	2640	2004	1395	968	968	1232
	lb	770	2063	2367	2486	2266	1914

**HOIST PERFORMANCE**

Layer	Max Line Pull	Normal Line Speed	High Line Speed
	lb	ft/min	ft/min
1	1650*	48.2	N/A
2	1540*	52.1	N/A
3	1430*	55.1	N/A
4	1320	59.0	N/A

(\*) 1320lb LMI limited

Wire Rope	Diameter	Tot. Length	Max Load
	in	ft	lb
A4L 19x7 right lang lay	1/4	190	7782

**HOOK BLOCK**



LOAD	No. of	
	Sheaves	Lines
1950	1	2
1320		1

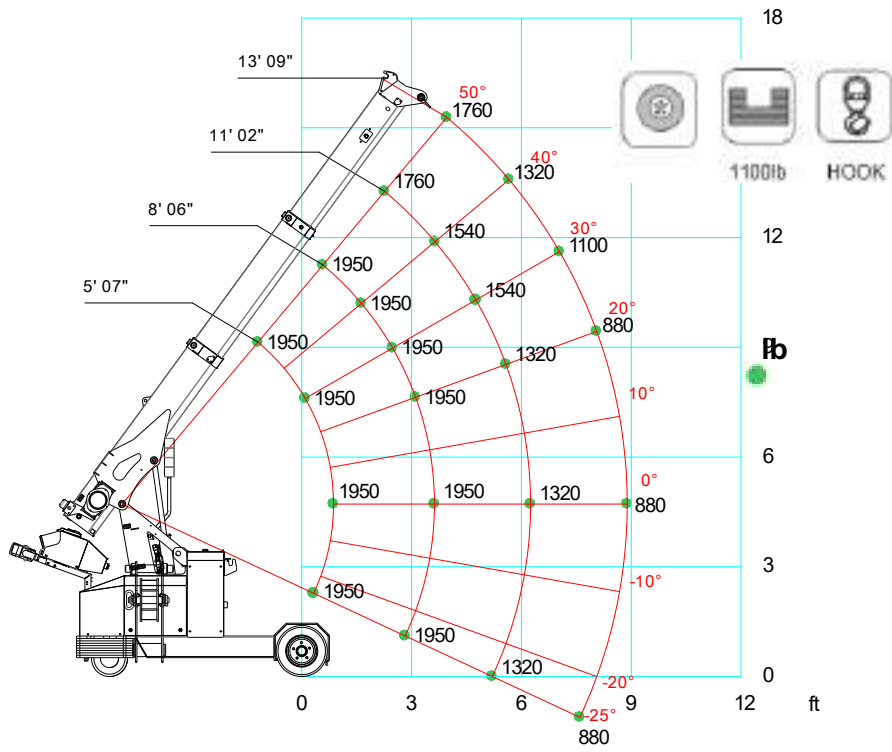

## MPK10WD - HOOK



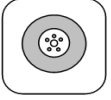
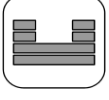

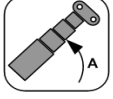

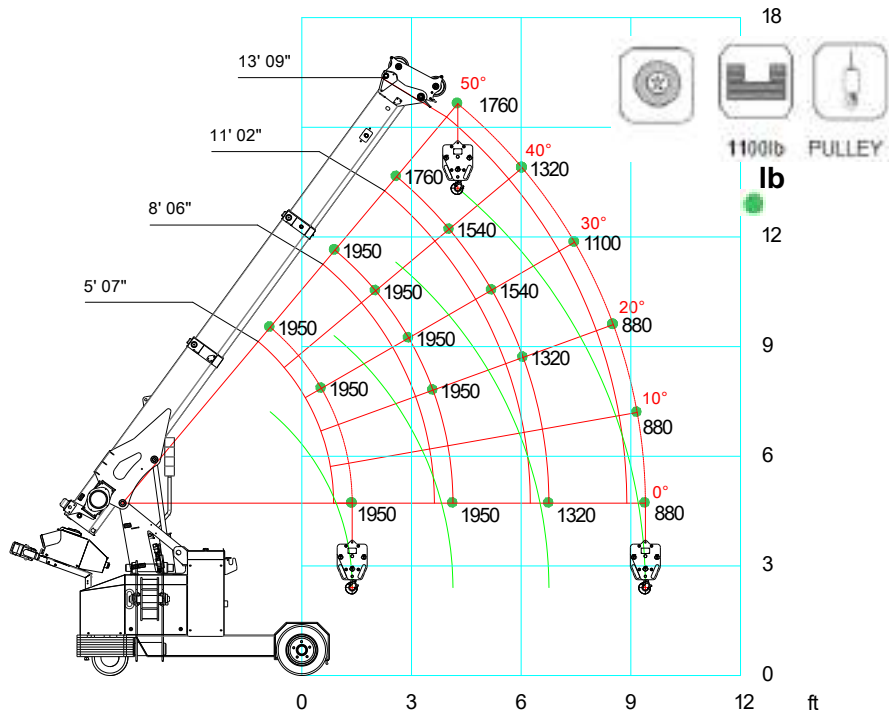

[ft] [lb]							
	1100lb			HOOK			
	5' 07"	7' 03"	8' 06"	9' 10"	11' 02"	12' 06"	13' 09"
50°	1950	1950	1950	1760	1760	1760	1760
45°	1950	1950	1950	1760	1760	1716	1540
40°	1950	1950	1950	1760	1540	1606	1320
35°	1950	1950	1950	1760	1540	1320	1100
30°	1950	1950	1950	1760	1540	1320	1100
25°	1950	1950	1950	1540	1320	1100	880
20°	1950	1950	1950	1540	1320	1100	880
15°	1950	1950	1950	1540	1320	1100	880
10°	1950	1950	1950	1540	1320	1100	880
5°	1950	1950	1950	1540	1320	1100	880
0°	1950	1950	1950	1540	1320	1100	880
-5°	1950	1950	1950	1540	1320	1100	880
-10°	1950	1950	1950	1540	1320	1100	880
-15°	1950	1950	1950	1540	1320	1100	880
-20°	1950	1950	1950	1540	1320	1100	880
-25°	1950	1950	1950	1540	1320	1100	880

MPK0020.04.02.000.2.06.15.A

## MPK10WD + WINCH W600

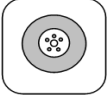
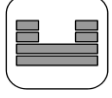

[ft] [lb]							
	1100lb PULLEY						
	6' 03"	7' 10"	9' 02"	10' 06"	11' 10"	13' 01"	14' 05"
50°	1950	1950	1950	1760	1760	1760	1760
45°	1950	1950	1950	1760	1760	1716	1540
40°	1950	1950	1950	1760	1540	1606	1320
35°	1950	1950	1950	1760	1540	1320	1100
30°	1950	1950	1950	1760	1540	1320	1100
25°	1950	1950	1950	1540	1320	1100	880
20°	1950	1950	1950	1540	1320	1100	880
15°	1950	1950	1950	1540	1320	1100	880
10°	1950	1950	1950	1540	1320	1100	880
5°	1950	1950	1950	1540	1320	1100	880
0°	1950	1950	1950	1540	1320	1100	880

MPK0020.04.02.000.1.06.15.A

## MPK10WD + JIB500G

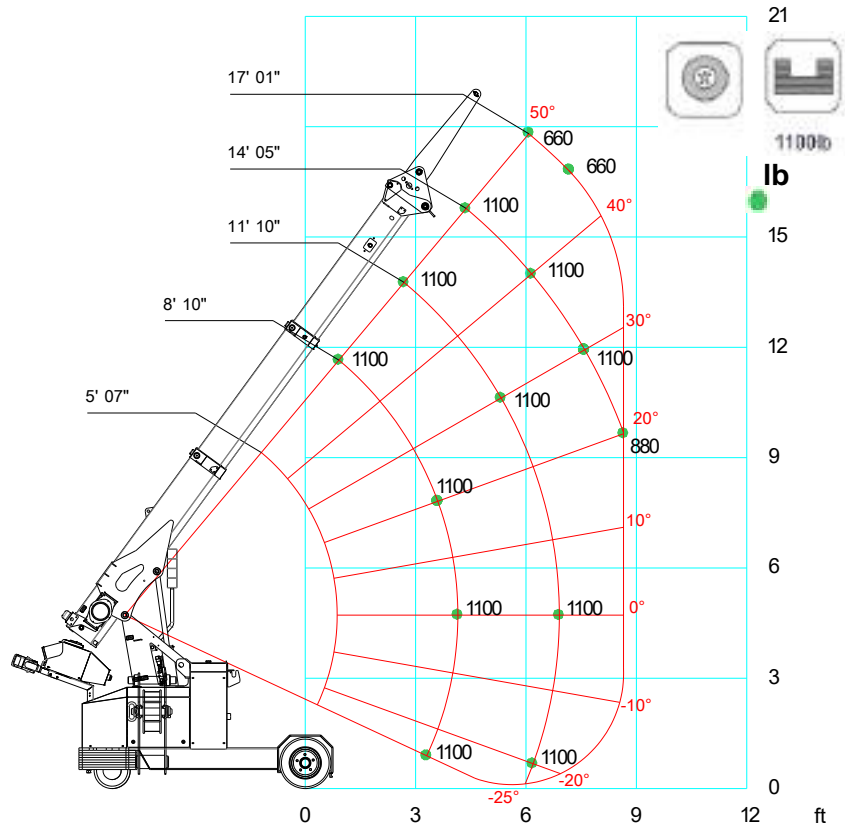

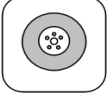
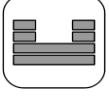
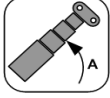
[ft] [lb]							
	JIB500G	1100lb					
	8' 10"	10' 06"	11' 10"	13' 01"	14' 05"	15' 09"	17' 01"
50°	1100	1100	1100	1100	1100	1100	660
45°	1100	1100	1100	1100	1100	1100	660
40°	1100	1100	1100	1100	1100	880	
35°	1100	1100	1100	1100	1100	880	
30°	1100	1100	1100	1100	1100		
25°	1100	1100	1100	1100	880		
20°	1100	1100	1100	1100	880		
15°	1100	1100	1100	1100			
10°	1100	1100	1100	1100			
5°	1100	1100	1100	1100			
0°	1100	1100	1100	1100			
-5°	1100	1100	1100	1100			
-10°	1100	1100	1100	1100			
-15°	1100	1100	1100	1100			
-20°	1100	1100	1100				
-25°	1100						

MPK0020.04.02.300.2.06.15.A

## MPK10WD + MR800

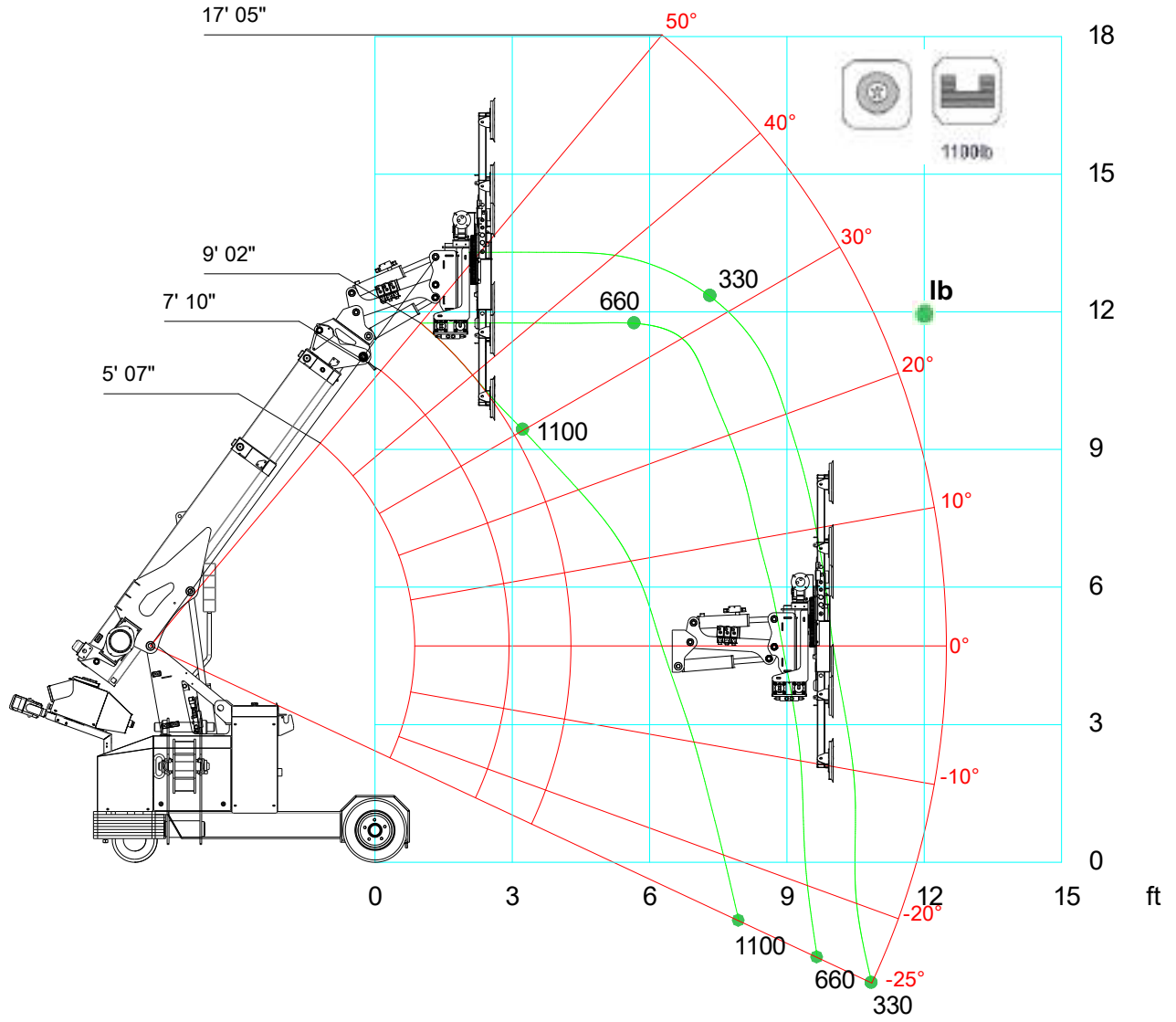

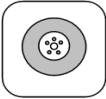
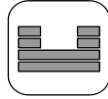
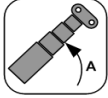
[ft] [lb]							
	MR800	1100lbs					
	8' 02"	10' 10"	12' 02"	13' 05"	14' 09"	16' 01"	17' 05"
50°	660	330					
45°	1100	330	330				
40°	1100	660	330	330			
35°	1100	660	660	330			
30°	1100	660	660	660			
25°	1100	660	660	660	330		
20°	1100	660	660	660	330		
15°	1100	660	660	660	330		
10°	1100	1100	660	660	330		
5°	1100	1100	660	660	330		
0°	1100	1100	660	660	330		
-5°	1100	1100	660	660	330		
-10°	1100	1100	1100	660	660		
-15°	1100	1100	1100	660	660	330	
-20°	1100	1100	1100	1100	660	330	
-25°	1100	1100	1100	1100	660	660	330

MPK0020.04.02.430.0.06.15.A

## ACCESSORIES

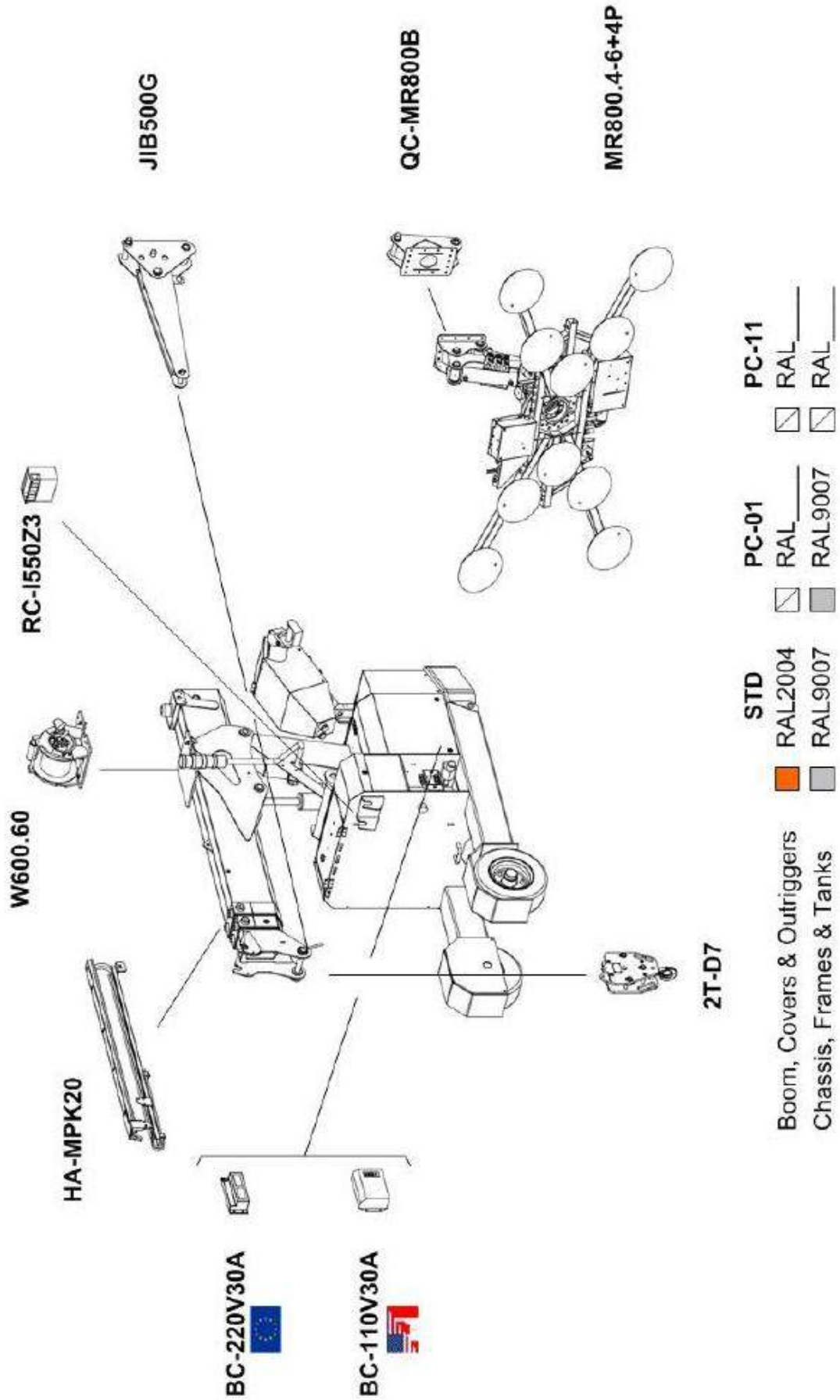





# ACCESSORIES FEATURES

## JIB500G

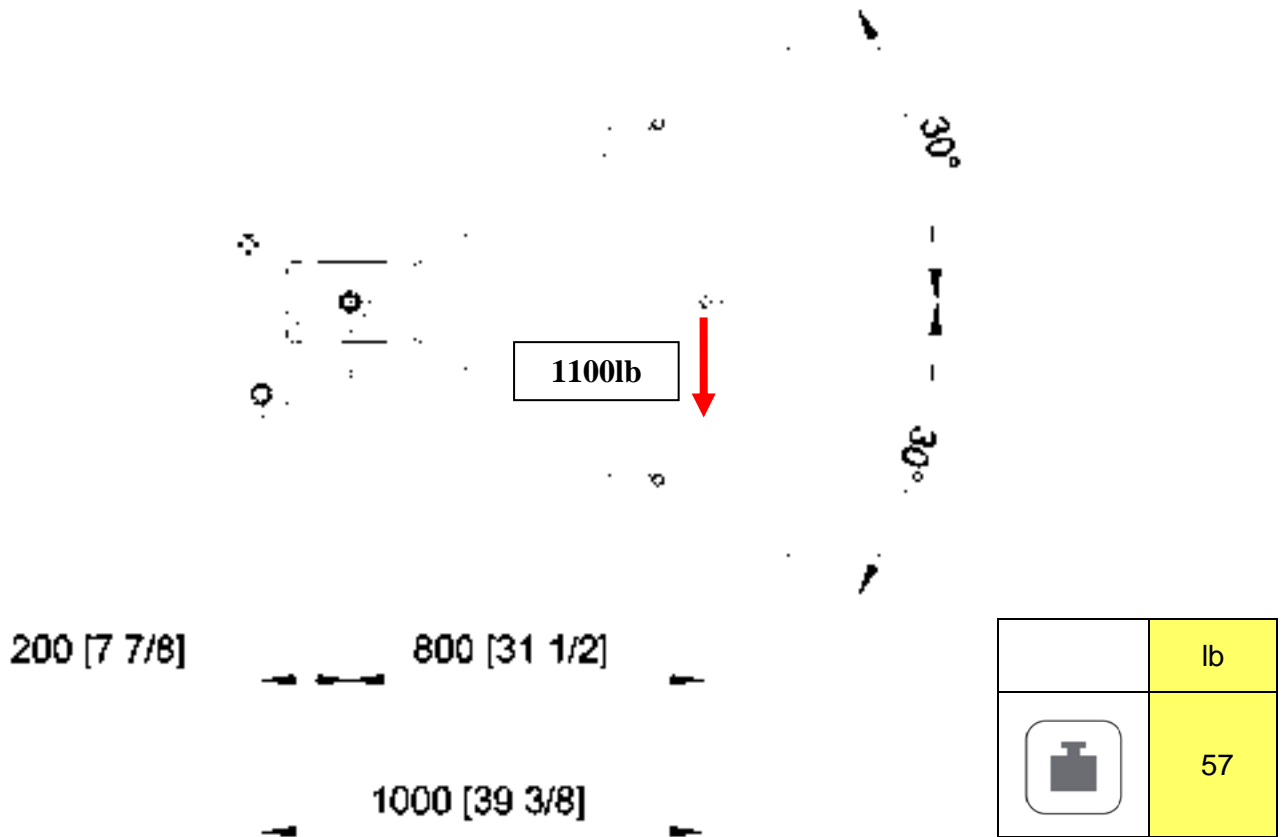



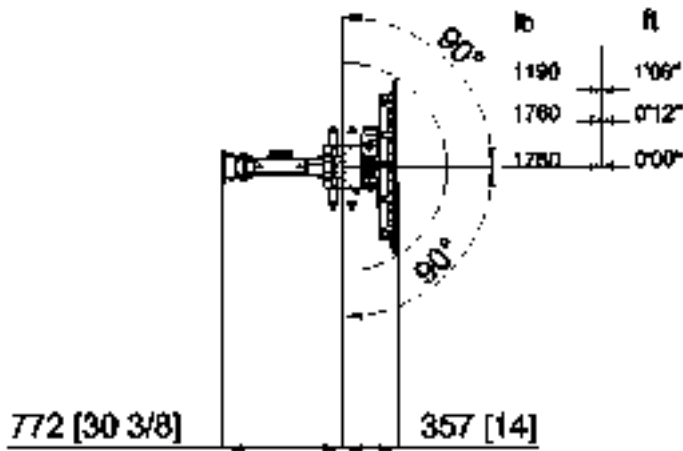
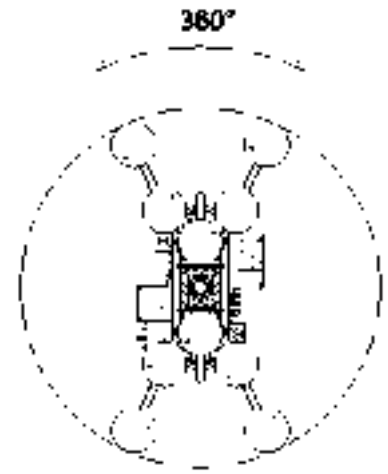
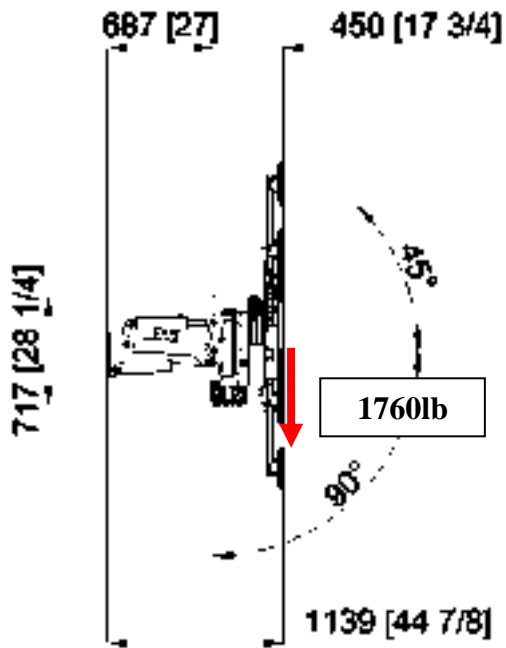









































## MR800-6+4P



	6	10	n°
	1188	1760	lb
	594	880	lb

	lb
	650

# SYMBOLS

	Weight		Chart Wheels		Engine		Jib length and angle
	Counterweight		Minipicker		Diesel Fuel		Jib Length
	Crane		Back Wheel Point Loading		Gasoline Fuel		Jib Radius
	Travel Speed		Front wheel Point Loading		Tank		Hydraulic Jib Length
	Gradeability		Travel Speed		Battery		Hydraulic Jib Radius
	Outrigger Load		Gradeability		Power		Mechanical Jib Length
	Track Loading		Working Radius		Boom Angle		Mechanical Jib Radius
	Outriggers Setup		Hookblock		Boom Length		Manipulator Length
	Ext Tracks Width		Slewing		Boom Radius		Manipulator Radius
	Chart On Tracks		Slewing Locked		Jib Hook Radius		Maximum inclination of the machinery
	Jib on board		Without jib on board		Stabilizing bar		Horizontal boom angle

## Remarks referring to load chart

- For the calculation of the load charts at least a wind speed of 30 ft/s (20 mph) and regarding the load a sail area of 1m<sup>2</sup> (1,2 yd<sup>2</sup>) per metric ton (2205 lb) load and a wind resistance coefficient of 1.2 on the load have been taken into account. For lifting of loads with large sail areas and/or high wind resistance coefficients the maximum wind speed as stated in the load charts has to be reduced.
- Lifting capacities are given in pounds.
- The weight of the hook blocks and hooks is part of the load and therefore it must be deducted from the lifting capacities.
- Working radii are measured from the slewing centre.
- The lifting capacities given for the telescopic boom apply if the folding jib is removed.
- Subject to modification of lifting capacities.

NOTES

NOTES



DEALER



JEKKO S.r.l. via Campardone, 1 Z.I. 31014 Colle Umberto (TV) Italy  
tel. +39 0438 1710083 fax +39 0438 1710123  
[www.jekko.it](http://www.jekko.it) - [info@jekko.it](mailto:info@jekko.it)